



Diesel Forklift Trucks 22,000 to 40,000 lb. Capacity

H100, H120, H140, H150, H160, H180, H100-1200, H120-1200, H140-1200 and H160-1200

SERIES 1401

Safety

Precise load control and maneuverability, even in constricted areas, are assured at all times. Centered and forward placement of the cab provides maximum through-the-mast visibility of fork tips and load. Generous use of glass panels, together with a curved windshield guarantees unsurpassed all around visibility.

Performance

Linde trucks operate efficiently and gently, even when handling heavy loads. Thanks to the hydrostatic drive system the machine will accelerate and decelerate smoothly and without shift-shock, from slow pace to full speed and back. Time savings and performance will further increase with Linde Dual Pedal Travel Control and Linde Load Control. Without effort, the operator is able to maneuver truck and load smoothly and quickly in any application.

Comfort

The floating operator cab is mounted on high density rubber bearings, isolating it from engine vibrations. Additionally, a high comfort hydraulic suspension seat further dampens any residual pulsation and shock due to operating surface conditions. In addition, fingertip hydraulic controls, built into an ergonomically optimized armrest, contribute to fatigue-free operation throughout the day.

Linde Material Handling



Reliability & Durability

The exceptionally durable Linde hydrostatic drive system, together with an equally dependable Cummins diesel engine, provide unmatched reliability and performance. This proven power-pack combination will deliver long service life.

Economic

The original Linde hydrostatic drive system operates without mechanical transmission, torque converter, clutch, differential and conventional brakes. The net effect: Low operating costs and increased productivity, a significant advantage especially in high cycle applications.

Standard and optional equipment

Standard equipment:

Full-time hydrostatic drive
High-performance hydraulic oil filter
On-Demand hydrostatic power steering
Abundant storage space
Lockable, under the seat storage
High comfort, fully adjustable, hydraulic suspension seat including seat belt
Height adjustable steering column
Internal rear view mirror
Back-up alarm
Glare free status display, fuel gauge, hour meter, clock, information and control lights for complete engine and drive system monitoring

Linde Load Control with "individual" single function hydraulic levers, and integral armrest
4-Function hydraulic valve and reeving (lift + tilt + 2)
Full cab, heater/defroster, front-top-rear washer and wipers
Side tilt cab, electric powered, with manual backup
Cummins QSB 6.7 liter diesel engine (Tier III Certified)
Engine intake air cleaner with integrated safety filter element
Dual pedal directional travel controls
Pneumatic tires
Linde integral sideshifting/fork positioning carriage (shaft/pin-type)
12 V Power (cab)

Options:

Single drive pedal with direction selector on armrest
17° Pivoting operator seat
External rear view mirrors
Sun shades for front and top lass
Up to 6-function hydraulic valve (lift + tilt +4)/reeving
Dual and triple masts with full free lift
Deluxe fully adjustable, air suspension seat
Rear-view camera system

Climate control with pollen filter/AC system
Additional lighting options
Hydraulic accumulator
High mounted engine air intake
Additional (passenger) seat
SE tires
Optional carriages

Other options available on request

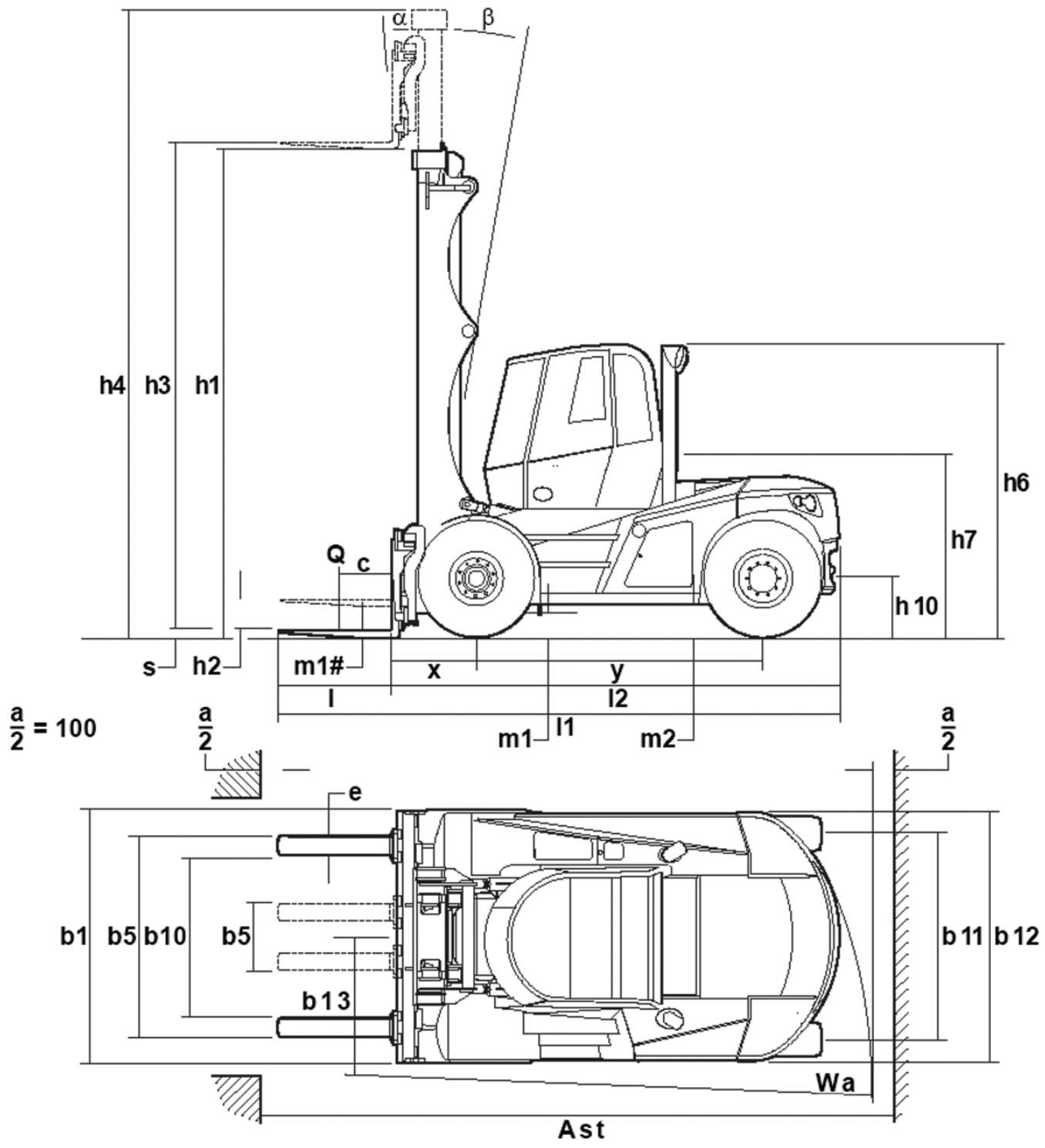

Technical data

April 2016 / Series 1401

Characteristics	1.1	Manufacturer		Linde	Linde	Linde
	1.2	Model designation		H100	H120	H140
	1.3	Power unit: battery, diesel, gasoline, LP gas		Diesel	Diesel	Diesel
	1.4	Operation: manual, pedestrian, rider standing, rider seated, order picker		Rider seated	Rider seated	Rider seated
	1.5	Load capacity	Q lb	22000	26000	31000
	1.6	Load center (axle center to fork face)	c in	24	24	24
	1.8	Load distance (front overhang)	x in	32.8	32.8	34.1
	1.9	Wheelbase	y in	116.5	116.5	116.5
	Weight	2.1	Service weight	lb	36376	38385
2.2		Axle loading with load, front/rear	lb	50128 / 8248	58167 / 6673	66879 / 9874
2.3		Axle loading without load, front/rear	lb	16991 / 19385	18913 / 19471	20717 / 2508
Wheels & Tires	3.1	Tire type - front/rear: C (cushion), SE (cushion super elastic), P (pneumatic)		P/P	P/P	P/P
	3.2	Tire size: front	in	10 x 20 / 16 PR	10 x 20 / 16 PR	12 x 20 / 20 P
	3.3	Tire size: rear	in	10 x 20 / 16 PR	10 x 20 / 16 PR	12 x 20 / 20 P
	3.5	Wheels: number front/rear (x = driven)		4 x / 2	4 x / 2	4 x / 2
	3.6	Track width, front	b10 in	73.8	73.8	73.8
	3.7	Track width, rear	b11 in	69.6	69.6	69.6
	Dimensions	4.1	Mast/fork carriage tilt: forward/back (Also see mast table)	a/b (°)	15 / 10	15 / 10
4.2		Height of mast lowered	h1 in	See mast table	See mast table	See mast table
4.3		Free lift	h2 in	See mast table	See mast table	See mast table
4.4		Lift	h3 in	See mast table	See mast table	See mast table
4.5		Height of mast extended	h4 in	See mast table	See mast table	See mast table
4.7		Height of overhead guard/cab	h6 in	117.8	117.8	119.2
4.8		Height of seat	h7 in	73.7	73.7	75
4.12		Height of tow coupling	h10 in	20.3	20.3	21.7
4.19		Overall length	l1 in	234.1	234.1	240.2
4.20		Length to fork face	l2 in	179	179	185.1
4.21		Overall width	b1/b2 in	100.2 / 100.2	100.2 / 100.2	100.2 / 100.2
4.22		Fork dimensions	s/e/l in	3.5 / 7.8 / 55.1 ³	3.5 / 7.8 / 55.1 ³	3.9 / 7.9 / 55.1 ³
4.23		Fork carriage		SS / FP	SS / FP	SS / FP
4.24		Width of fork carriage	b3 in	100.2	100.2	100.2
4.25		Fork spread, min/max	b5 in	24 / 89.5	24 / 89.5	24.4 / 87.4
4.31		Ground clearance under mast, with load	m1 in	6.8	6.8	7.9
4.32		Ground clearance, center of wheelbase	m2 in	10.0	10.0	11.3
4.33	Aisle width	Ast in	194.1 ¹	194.1 ¹	195.4 ¹	
4.35	Turning radius	Wa in	161.3	161.3	161.3	
Performance	5.1	Travel speed, with/without load	mph	17.3 / 18.5	17.3 / 18.5	18.5 / 19.3
	5.2	Lifting speed, with/without load	fpm	102.4 / 110.2	102.4 / 106.3	80.7 / 86.6
	5.3	Lowering speed, with/without load	fpm	102.4 / 90.6	104.3 / 92.5	106.3 / 82.7
	5.6	Maximum tractive force, with/without load (5 min. rating)	lbs dbp	12800 / 12800	12800 / 12800	17400 / 17400
	5.9	Gradeability, with/without load	%	22.5 / 22.5	22.5 / 22.5	26.8 / 26.8
	5.10	Service brake		Hydrostatic / wet disc		
Drive	6.4	Battery voltage/rated capacity	V/Ah	24 (2 x 12) / 95	24 (2 x 12) / 95	24 (2 x 12) / 95
	7.1	Engine manufacturer/type		Cummins / QSB 6.7		
	7.2	Engine performance to ISO 1585	hp	173	173	173
	7.3	Rated speed	rpm	2200	2200	2200
	7.4	Number of cylinders/engine displacement	cu in	6 / 409	6 / 409	6 / 409
Other	8.1	Drive control		Hydraulic		
	8.2	Working pressure for attachments	psi	3625	3625	3625
	8.3	Oil flow for attachments	gal/min	1.3 - 26.3	1.3 - 26.3	1.3 - 26.3
	8.4	Noise level at driver's ear (to EN 12053)	dBa	75	75	75

¹ Add load length Plus safety margin

² Trucks rated at 48" load center

³ All forks standard tapered pin-type

⁴ Capacity ratings can be affected by changing forks, load center, and/or drive tires

Linde	Linde	Linde	Linde	Linde	Linde	1.1
H150	H160	H180	H120/1200 ²	H140/1200 ²	H160/1200 ²	1.2
Diesel	Diesel	Diesel	Diesel	Diesel	Diesel	1.3
Rider seated	Rider seated	Rider seated	Rider seated	Rider seated	Rider seated	1.4
33000	35000	40000	26000	31000	35000	1.5
24	24	24	48	48	48	1.6
34.1	34.1	34.1	34.1	35.9	35.9	1.8
116.5	129.9	129.9	129.9	129.9	141.7	1.9
47113	45810	47159	46478	51656	53508	2.1
70757 / 9425	74505 / 6579	78877 / 7965	67999 / 4934	75131 / 7390	80325 / 8457	2.2
21299 / 25814	23550 / 22260	21552 / 25607	24974 / 21504	24513 / 27143	24357 / 29152	2.3
P/P	P/P	P/P	P/P	P/P	P/P	3.1
12 x 20 / 20 PR	12 x 20 / 20 PR	12 x 20 / 20 PR	12 x 20 / 20 PR	12 x 20 / 20 PR	12 x 20 / 20 PR	3.2
12 x 20 / 20 PR	12 x 20 / 20 PR	12 x 20 / 20 PR	12 x 20 / 20 PR	12 x 20 / 20 PR	12 x 20 / 20 PR	3.3
4 x / 2	4 x / 2	4 x / 2	4 x / 2	4 x / 2	4 x / 2	3.5
73.8	73.8	73.8	73.8	73.8	73.8	3.6
69.6	69.6	69.6	69.6	69.6	69.6	3.7
15 / 10	15 / 10	15 / 10	15 / 10	15 / 10	15 / 10	4.1
See mast table	See mast table	See mast table	See mast table	See mast table	See mast table	4.2
See mast table	See mast table	See mast table	See mast table	See mast table	See mast table	4.3
See mast table	See mast table	See mast table	See mast table	See mast table	See mast table	4.4
See mast table	See mast table	See mast table	See mast table	See mast table	See mast table	4.5
119.2	119.2	119.2	119.2	119.2	119.2	4.7
75	75	75	75	75	75	4.8
21.7	21.7	21.7	21.7	21.7	21.7	4.12
240.2	253.6	253.6	293	294.8	306.6	4.19
185.1	198.5	198.5	198.5	200.3	212.1	4.20
100.2 / 100.2	100.2 / 100.2	100.2 / 100.2	100.2 / 100.2	100.2 / 100.2	100.2 / 100.2	4.21
3.9 / 7.9 / 55.1 ³	3.9 / 7.9 / 55.1 ³	3.9 / 7.9 / 55.1 ³	3.9 / 7.9 / 94.5 ³	3.9 / 9.8 / 94.5 ³	3.9 / 9.8 / 94.5 ³	4.22
SS / FP	SS / FP	SS / FP	SS / FP	SS / FP	SS / FP	4.23
100.2	100.2	100.2	100.2	100.2	100.2	4.24
24.4 / 87.4	24.4 / 87.4	24.4 / 87.4	24.4 / 87.4	28.3 / 87.4	28.3 / 87.4	4.25
7.9	7.9	7.9	7.9	7.9	7.9	4.31
11.3	11.3	11.3	11.3	11.3	11.3	4.32
195.4 ¹	211.8 ¹	211.8 ¹	211.8 ¹	213.6 ¹	225.0 ¹	4.33
161.3	177.7	177.7	177.7	177.7	189.1	4.35
18.5 / 19.3	18.5 / 19.3	18.5 / 19.3	18.5 / 19.3	18.5 / 19.3	18.5 / 19.3	5.1
80.7 / 86.6	78.7 / 88.6	72.8 / 66.9	84.7 / 88.6	78.7 / 88.6	78.7 / 88.6	5.2
106.3 / 82.7	106.3 / 80.7	104.3 / 63.0	108.3 / 84.6	110.2 / 88.6	110.2 / 88.6	5.3
17400 / 17400	17400 / 17400	17400 / 17400	17400 / 17400	17400 / 17400	17400 / 17400	5.6
26.8 / 26.8	26.8 / 26.8	26.8 / 26.8	23.0 / 23.0	21.0 / 21.0	21.0 / 21.0	5.9
Hydrostatic / wet disc			Hydrostatic / wet disc			5.10
24 (2 x 12) / 95	24 (2 x 12) / 95	24 (2 x 12) / 95	24 (2 x 12) / 95	24 (2 x 12) / 95	24 (2 x 12) / 95	6.4
Cummins / QSB 6.7			Cummins / QSB 6.7			7.1
173	173	173	173	173	173	7.2
2200	2200	2200	2200	2200	2200	7.3
6 / 409	6 / 409	6 / 409	6 / 409	6 / 409	6 / 409	7.4
Hydraulic			Hydrostatic			8.1
3625	3625	3625	3625	3625	3625	8.2
1.3 - 26.3	1.3 - 26.3	1.3 - 26.3	1.3 - 26.3	1.3 - 26.3	1.3 - 26.3	8.3
75	75	75	75	75	75	8.4

Capacity*

1401 SERIES H100 / H120		Capacity (lb.) @ 24" Load Center ⁴								Tires: Dual Pneu 10x20/16 ⁴				Forks 2.75x7x45" ³			
Mast	H100	22000	22000	22000	22000	22000	22000	20815	19720	22000	22000	22000	22000	22000	22000	20815	19720
Mast	H120	26000	26000	26000	26000	26000	26000	24980	23665	26000	26000	26000	26000	26000	26000	24980	23665
Type	Simple / Dual / Triple	Simple	Simple	Simple	Simple	Simple	Simple	Simple	Simple	Dual	Dual	Dual	Dual	Dual	Dual	Dual	Dual
h1	Height of mast, lowered	121.5	131.5	141.0	151.0	161.0	170.5	180.5	190.5	126.0	136.0	146.0	155.5	165.5	175.5	185.0	195.0
h2	Free lift	0	0	0	0	0	0	0	0	64.0	74.0	83.5	93.5	103.0	113.0	123.0	132.0
h3	Lift	138.0	137.5	177.0	196.5	216.5	236.0	256.0	275.5	138.0	157.5	177.5	197.0	216.5	236.5	256.0	276.0
h4	Height of mast, extended	190.5	210.0	230.0	249.5	269.0	289.0	308.5	328.0	200.0	220.0	239.5	259.5	279.0	298.5	318.5	338.0
Forks ³	Tilt forward / back	15/7	15/10	15/10	15/10	15/10	15/10	15/10	15/10	15/7	15/10	15/10	15/10	15/10	15/10	15/10	15/10

1401 SERIES H140 / H150 / H160 / H180		Capacity (lb.) @ 24" Load Center ⁴								Tires: Dual Pneu 10x20/20 PR ⁴				Forks 3.5x7x45" ³			
Mast	H140	31000	31000	31000	31000	31000	31000	29175	27640	31000	31000	31000	31000	31000	31000	29175	27640
Mast	H150	33000	33000	33000	33000	33000	33000	31260	29615	33000	33000	33000	33000	33000	33000	31260	29615
Mast	H160	35000	35000	35000	35000	35000	35000	33340	31585	35000	35000	35000	35000	35000	35000	33340	31585
Mast	H180	40000	40000	40000	40000	40000	40000	37505	35535	40000	40000	40000	40000	40000	40000	37505	35535
Type	Simple / Dual / Triple	Simple	Simple	Simple	Simple	Simple	Simple	Simple	Simple	Dual	Dual	Dual	Dual	Dual	Dual	Dual	Dual
h1	Height of mast, lowered	134.5	144.5	154.0	164.0	174.0	183.5	193.5	203.5	134.0	144.5	154.0	164.0	174.0	183.5	193.5	203.5
h2	Free lift	0	0	0	0	0	0	0	0	69.0	79.0	89.0	98.5	108.5	118.0	128.0	138.0
h3	Lift	138.0	157.5	177.0	196.5	216.5	236.0	256.0	275.5	138.0	157.5	177.0	196.5	216.5	236.0	256.0	275.5
h4	Height of mast, extended	203.5	223.0	243.0	262.5	282.0	302.0	321.5	341.0	203.5	223.0	243.0	262.5	282.0	302.0	321.5	341.0
Forks ³	Tilt forward / back	15/9	15/10	15/10	15/10	15/10	15/10	15/10	15/10	15/9	15/10	15/10	15/10	15/10	15/10	15/10	15/10

1401 SERIES H120-1200		Capacity (lb.) @ 48" Load Center ⁴								Tires: Dual Pneu 10x20/20 PR ⁴				Forks 3.5x7x94.5" ³			
Mast	H120-1200	26000	26000	26000	26000	26000	26000	24950	23635	26000	26000	26000	26000	26000	26000	24950	23635
Type	Simple / Dual / Triple	Simple	Simple	Simple	Simple	Simple	Simple	Simple	Simple	Dual	Dual	Dual	Dual	Dual	Dual	Dual	Dual
h1	Height of mast, lowered	134.5	144.5	154.0	164.0	174.0	183.5	193.5	203.5	134.5	144.5	154.0	164.0	174.0	183.5	193.5	203.5
h2	Free lift	0	0	0	0	0	0	0	0	69.0	79.0	89.0	98.5	109.0	119.0	128.0	138.0
h3	Lift	138.0	157.5	177.0	196.5	216.5	236.0	256.0	275.5	138.0	157.5	177.0	196.5	216.5	236.0	256.0	275.5
h4	Height of mast, extended	203.5	223.0	243.0	262.5	282.0	302.0	321.5	341.0	203.5	223.0	243.0	262.5	282.0	302.0	321.5	341.0
Forks ³	Tilt forward / back	15/9	15/10	15/10	15/10	15/10	15/10	15/10	15/10	15/9	15/10	15/10	15/10	15/10	15/10	15/10	15/10

1401 SERIES H140-1200 / H160-1200		Capacity (lb.) @ 48" Load Center ⁴								Tires: Dual Pneu 10x20/20 PR ⁴				Forks 4.0x8x94.5" ³			
Mast	H140-1200	31000	31000	31000	31000	31000	31000	28990	27460	31000	31000	31000	31000	31000	31000	28990	27460
Mast	H160-1200	35000	35000	35000	35000	35000	35000	33235	31390	35000	35000	35000	35000	35000	35000	33235	31390
Type	Simple / Dual / Triple	Simple	Simple	Simple	Simple	Simple	Simple	Simple	Simple	Dual	Dual	Dual	Dual	Dual	Dual	Dual	Dual
h1	Height of mast, lowered	134.5	144.5	154.0	164.0	174.0	183.5	193.5	203.5	134.5	144.5	154.0	164.0	174.0	183.5	193.5	203.5
h2	Free lift	0	0	0	0	0	0	0	0	69.0	79.0	89.0	98.5	109.0	119.0	128.0	138.0
h3	Lift	138.0	157.5	177.0	196.5	216.5	236.0	256.0	275.5	138.0	157.5	177.0	196.5	216.5	236.0	256.0	275.5
h4	Height of mast, extended	203.5	223.0	243.0	262.5	282.0	302.0	321.5	341.0	203.5	223.0	243.0	262.5	282.0	302.0	321.5	341.0
Forks ³	Tilt forward / back	15/9	15/10	15/10	15/10	15/10	15/10	15/10	15/10	15/9	15/10	15/10	15/10	15/10	15/10	15/10	15/10

**Capacity ratings can be affected by changing forks, load center, and/or drive tires.

Downrating Charts*

Reference pneumatic tires with Linde integral sideshifting/fork positioning carriage and forks.

H100 (Simple Mast)

H100 (1401) Load Center Lifting Capacity Diagram

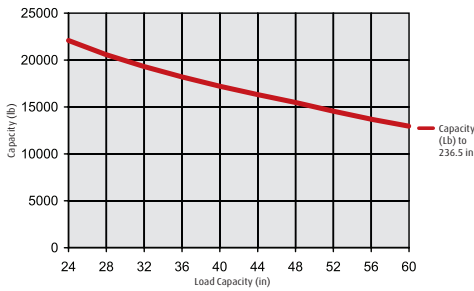

H120 (Simple Mast)

H120 (1401) Load Center Lifting Capacity Diagram

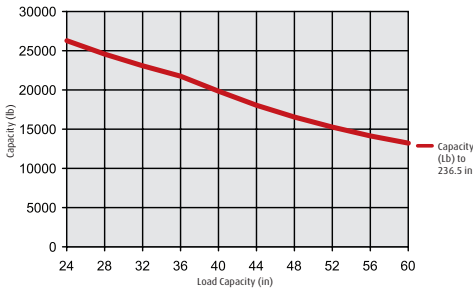

H140 (Simple Mast)

H140 (1401) Load Center Lifting Capacity Diagram

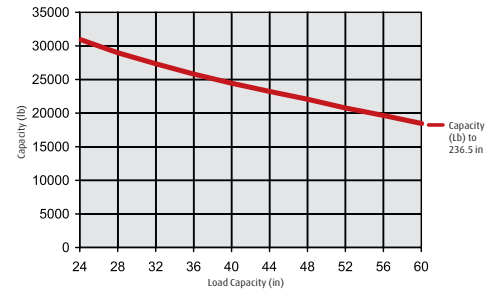

H150 (Simple Mast)

H150 (1401) Load Center Lifting Capacity Diagram

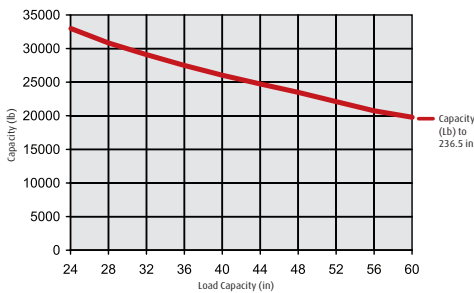

H160 (Simple Mast)

H160 (1401) Load Center Lifting Capacity Diagram

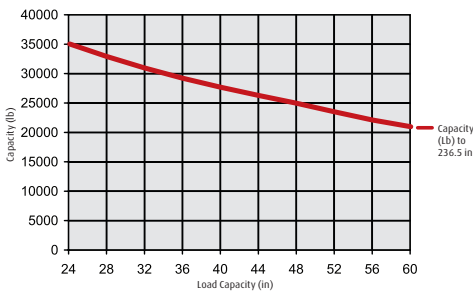

H180 (Simple Mast)

H180 (1401) Load Center Lifting Capacity Diagram

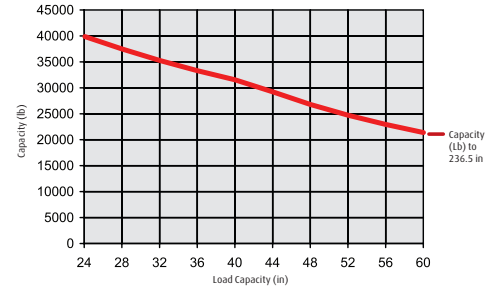

H120-1200 (Simple Mast)

H120-1200 (1401) Load Center Lifting Capacity Diagram

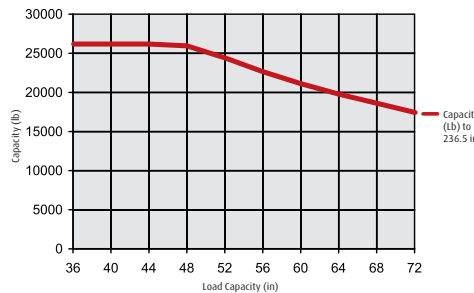

H140-1200 (Simple Mast)

H140-1200 (1401) Load Center Lifting Capacity Diagram

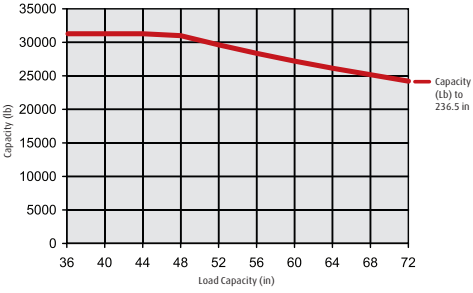

H160-1200 (Simple Mast)

H160-1200 (1401) Load Center Lifting Capacity Diagram

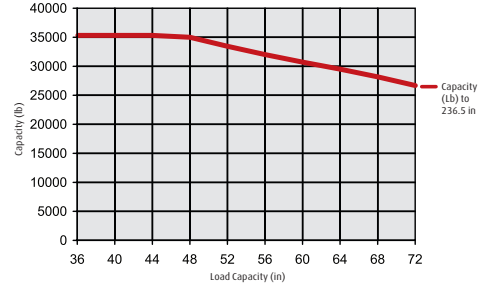

* For quick reference only, contact factory for detailed ratings.

Features

Original Linde Hydrostatic Drive

- Eliminates clutch, conventional brakes, differential, mechanical transmission and torque converter
- Low rpm, high torque diesel engine, perfectly matched to drive system and hydraulic requirements



Operator's Compartment

- Centered, forward positioned, floating/shock-mounted
- Impact tested and integrated overhead guard
- Unmatched all around visibility

Linde Travel Control (LTC)

- Instantaneous directional changes
- Precise control without shift shock
- Lower fatigue, improved productivity



Linde Load Control (LLC)

- Effortless load handling with fingertips
- Precision placement and transfer of loads
- Complete separation of travel and lifting



Advanced, Powerful Diesel Engine

- Cummins, Tier IV, Interim Emissions Certified
- 6 cylinder, 6.7 liter displacement
- Maximum torque at 1400 rpm
- 72.5 gal. Capacity fuel tank (diesel)

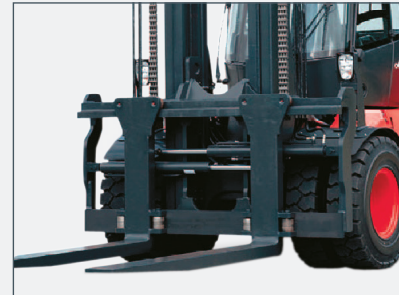

Operational Controls

- Dual pedal travel control
- All switches within easy reach
- Glare-free, multi-function status display

Truck Control

- Automatic engine RPM adjustment to power demand
- Superior safety due to redundant control systems
- Extremely reliable CAN-bus electronic system

Linde Mast

- Distinctive mast rails, specifically developed to handle high torsion loads
- Optimized component placement
- Unsurpassed visibility



For more information on Linde material handling equipment, please contact:

KION North America Corporation

2450 West 5th North Street, Summerville, SC 29483

Phone: (843) 875-8000 Truck Sales Fax: (843) 875-8471

E-mail: trucksales.na@kiongroup.com

www.kion-na.com

ANSI: Standard truck meets all applicable mandatory requirements of ANSI/ITSDF B56.1 standards for powered industrial trucks.
NOTE: Performance data may vary due to motor and system efficiency tolerances. The performance depicted represents nominal values obtained under typical operating conditions. Metric dimensions are in millimeters unless otherwise specified. All metric dimensions are not direct equivalents due to rounding data. The descriptions and specifications included on this data sheet were in effect at the time of printing. Linde Material Handling North America Corporation reserves the right to make improvements and changes in specification or design without notice and without incurring obligation. Please check with your authorized Linde dealer for information on possible updates or revisions.

linde_spec_1401_1013
USA_v13.1_100913_0730